

DIMinBOX DX2

2-Channel Universal Light Dimmer

ZDI-DBDX2

Application program version: [1.0]

User manual edition: [1.0]_b

www.zennio.com

CONTENTS

Contents	2
Document Updates	4
1 Introduction	5
1.1 DIMinBOX DX2.....	5
1.2 Load Types.....	7
1.2.1 Combining Load Types.....	7
1.3 Installation.....	9
2 Configuration	10
2.1 General.....	10
2.2 Channel Cx.....	13
2.2.1 Dimming	13
2.2.2 Characteristic Curve	18
2.2.3 Configuration.....	19
2.2.4 Status Objects.....	20
2.2.5 Custom On/Off	21
2.2.6 Simple Timer.....	22
2.2.7 Flashing.....	24
2.2.8 Scenes/Sequences	26
2.2.9 Lock Channel.....	29
2.2.10 Alarms.....	30
2.2.11 Auto Off	33
2.2.12 Initialisation	33

2.3	Channel C1+C2	35
2.4	Error Notifications	36
2.4.1	Bus Notifications	36
2.4.2	LED Indicators	36
2.4.3	Reaction to Errors	37
2.5	Inputs	41
2.5.1	Binary Input	41
2.5.2	Temperature Probe	42
2.5.3	Motion Detector	42
2.6	Logic Functions	43
2.7	Manual Control	44
2.7.1	Test On Mode	44
2.7.2	Test Off Mode	45
	ANNEX I: Communication Objects	46

DOCUMENT UPDATES

Version	Changes	Page(s)
[1.0]_b	Correction of the maximum power value.	5

1 INTRODUCTION

1.1 DIMinBOX DX2

DIMinBOX DX2 is the universal, **two-channel**, multi-function KNX light dimmer from Zennio. Its wide variety of functions makes it a versatile and robust device.

- Compatibility with **resistive (R)**, **inductive (L)**, **capacitive (C)**, **LED*** and low-consumption **CFL*** loads.

(*) Only dimnable LED / CFL lamps are supported.

- Maximum **per-channel power**:
 - At 230 VAC: 310 W for all load types.
 - At 110 VAC: 200 W for all load types.
- **High-performance regulation**: the device is entirely powered from the KNX bus, which prevents limitations and other effects over the load power.
- Automatic **frequency detection**.
- Possibility of automatic load type **detection** for conventional lamps (R / C / L),
- Compatibility with **Uninterruptible Power Supply** systems (UPS).
- Customisable **dimming pattern** for LED and CFL loads,
- Customisable **dimming times**.
- **Individual** or **joint** control of the two output channels,
- **Additional functions**: timed actions, scenes, custom On/Off controls, automatic switch-off, sequences, economy mode, channel lock...
- **Manual operation and supervision** of the loads through the on-board pushbuttons.
- 10 customisable, multi-operation **logic functions**.

- Automatic **error management** (short-circuits, overheating, anomalous network frequencies, overvoltage, absence of power supply and wrong load type selection).
- LED **indicators** to show error situations.
- 2 **multi-purpose inputs**, configurable as:
 - Temperature probes,
 - Binary inputs (i.e., pushbuttons, switches, sensors),
 - Motion detectors.
- Data storage and load switch-off on **bus power losses**.

1.2 LOAD TYPES

DIMinBOX DX2 supports the following load types:

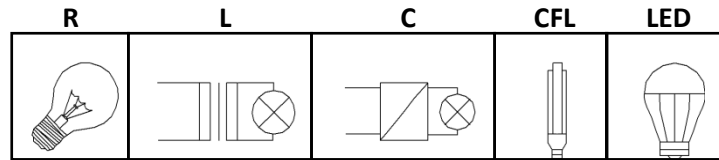

Figure 1 Load Types

- **Conventional lamps:**
 - Resistive (R),
 - Inductive (L),
 - Capacitive (C),
- Dimmable low-consumption **Compact Fluorescent Lamps (CFL)**.
- Dimmable Light Emitting Diode (**LED**) lamps.

1.2.1 COMBINING LOAD TYPES

In some cases it is possible to combine different load types in the same channel (i.e., it is possible to control loads of different types together) as long as the following restrictions are satisfied:

- Inductive (L) and resistive (R) loads **can** be combined if the resistive load is less than 50% of the total load.
- Capacitive (C) and resistive (R) loads **can** be combined if the resistive load is less than 50% of the total load.
- Capacitive (C) and inductive (L) loads **cannot** be combined.
- CFL and LED loads **cannot** be combined.
- CFL and conventional (R / L / C) loads **cannot** be combined.
- LED and conventional (R / L / C) loads **cannot** be combined.

- It is advisable **not to combine** different CFL (or LED) loads together in the same channel, as the response may differ depending on the model or maker.

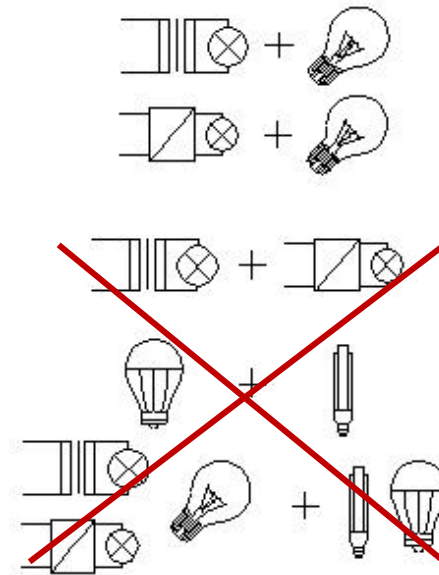

Figure 2. Combining Load Types.

To get further information, please refer to the corresponding **Datasheet**, bundled with the original package of the device and also available at www.zennio.com.

1.3 INSTALLATION

DIMinBOX DX2 connects to the KNX bus through the on-board KNX connector. Once the device is provided with power from the KNX bus, both the individual address and the associated application program can be downloaded.

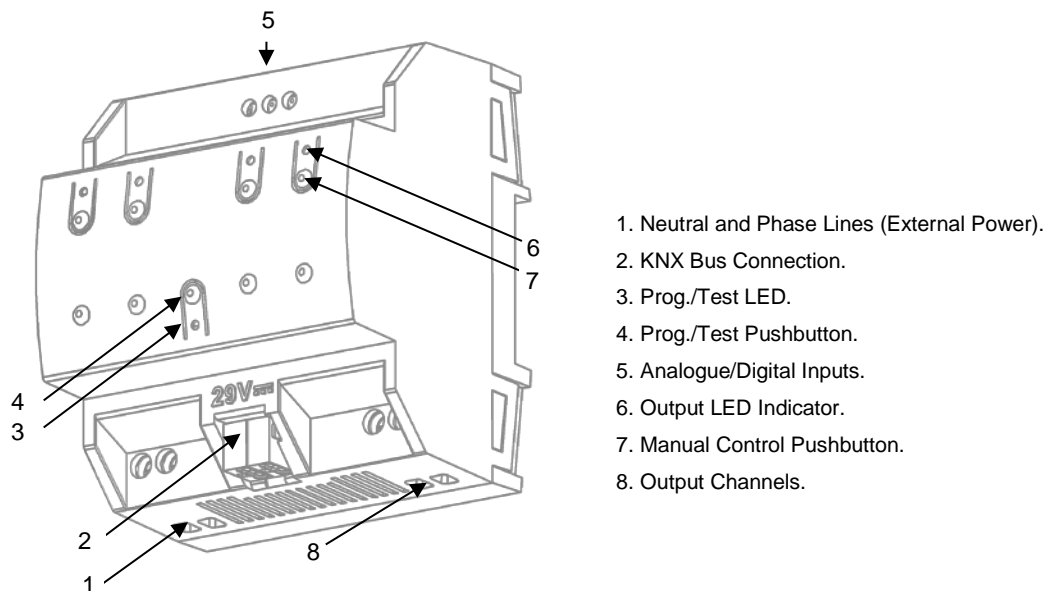

Figure 3 DIMinBOX DX2 - Element Diagram.

The main elements of the device are described next:

- **Test/Prog. Pushbutton (4):** a short press on this button sets the device into the programming mode, making the associated LED (3) light in red.

Note: if this button is held while plugging the device into the KNX bus, the device will enter into **safe mode**. The LED will blink in red every 0.5 seconds.

- **Output Channels (8):** slots for the connection of the output lines (loads).
- **Neutral and Phase Inputs (1):** slots for the connection of the voltage wires (neutral and phase lines).
- **Analogue-Digital Inputs (5):** input ports for the stripped cables of external elements such as switches, motion detectors, temperature probes, etc.

To get detailed information about the technical features of the device, as well as on the installation and security procedures, please refer to the corresponding **Datasheet**, bundled with the original package of the device and also available at www.zennio.com.

2 CONFIGURATION

2.1 GENERAL

The general configuration of DIMinBOX DX2 requires setting some general parameters common to both output channels:

- Whether to control the two channels **independently or jointly** (see section 2.2 and section 2.3).
- The length of the dimming course for the two **Smooth Dimming** functions, which make it possible to increase or decrease the light level of the loads progressively (in contrast to **At Once**). This length is defined as the time for an entire regulation, from a level of 0% (no light) to a level of 100% (full light).

***Note:** there are several ways of regulating the light level. Therefore, it will be necessary to set which cases should do it at once and which ones smoothly.*
- The **manual control** type, in the case that operating the channels through the on-board pushbuttons is necessary for testing or for other purposes.
- Whether to send **error notifications** or not to the bus.
- Enabling or disabling the **Inputs** module.
- Enabling or disabling the **Logic Functions** module.

ETS PARAMETERISATION

After importing the corresponding database in ETS and adding the device into the topology of the desired project, the configuration process begins by right-clicking into the device and selecting *Edit parameters*.

Note: once the device is in operation, it is advisable to switch off the loads prior to performing further parameter downloads from ETS.

The tab tree on the left shows the “**General**” tab in the first place, containing the following parameters:

Figure 4 General - Configuration.

- **Channel Configuration:** sets which channels will be functional, and whether they should be controlled independently or jointly.

- “C1 and C2 (independent channels)”: both channels will be functional, and will be controllable separately.
- “C1 + C2 (common channel)”, both channels will be functional, although will be controlled jointly.
- “C1 (independent channel)”, only channel C1 will operate.
- “C2 (independent channel)”, only channel C2 will operate.

Depending on the selection, the parameter tab tree on the left may contain more or less entries.

- **Smooth Dimming Times:** 5 to 50 tenths of a second, 1 to 120 seconds or 1 to 5 minutes. The longer the time, the smoother the light regulation.
 - **Smooth Dimming Time Objects:** enables or disables the **“Smooth Dimming Time 1”** and **“Smooth Dimming Time 2”** two-byte objects, which allow re-defining in runtime the dimming times initially defined in parameters.
- Manual Control:** the options are “Disabled”, “Test Mode Off + Test Mode On”, “Only with Test Mode Off” and “Only with Test Mode On”. Please see section 2.5 for details.

- **Error Notifications:** enables or disables the “Error Notifications” tab (within “General”), which contains specific parameters for the case DlMinBOX DX2 is required to report error events to the KNX bus. Please see section 2.1.4 for details.
- **Inputs:** enables or disables the “Inputs” tab, which contains specific parameters for the case of connecting external accessories to DlMinBOX DX2. Please see section 2.3 for details.
- **Logic Functions:** enables or disables the “Logic Functions” tab, which contains specific parameters for the case the Logic Functions module is required. Please see section 2.4 for details

2.2 CHANNEL Cx

The specific configuration for each independent channel that may have been enabled (C1, C2) entails setting the following options.

2.2.1 DIMMING

Regarding the light dimming function, the following options are available for each channel:

- The **load type**, which should be RCL (conventional loads), CFL or LED. Different dimming patterns are applied for each case. Please see section 1.2 for details.

- In the case of a **conventional** load (RCL), the integrator will have the option to **manually** set the type (R, C or L) or to let DMinBOX DX2 perform an **automatic** detection.

Note: *if the integrator opts for manually setting a conventional load type (R, C or L) and then installs the wrong type, DMinBOX DX2 will notify the KNX installation about it. See section 2.4.*

- In the case of a **CFL** or a **LED** load, the integrator will have the option to select the dimming pattern (among three options) that best fits the load being regulated. Next, it is necessary to select the dimming mode, that is, whether to regulate the load on the trailing edges of the wave or on the leading edges. Some testing with these options is advisable in order to obtain the best results for the specific lamp being regulated.

Note: *if the device detects issues while trying to regulate the load, it will consider that the selected dimming mode is wrong for the current load, and notify the KNX bus about it. See section 2.4*

- The **type of response** (immediate or smooth, with two smooth speeds available for configuration at the integrator's disposal) of the different light controls: precise dimming (i.e., orders to set a specific light level, expressed in terms of percentage), relative dimming (i.e., orders to increase or decrease the current light level by a certain percentage) and switch-on / switch-off.

- The **load switch-on method**, being possible to configure whether the loads should always recover their previous light level (the one they had before being switched off; this is referred to as “memory function”) when a new switch-on order arrives, or acquire their maximum level. In case of selecting ‘Previous’, the integrator may decide if a new switch-on overwrites the saved value and go to maximum or it is ignored, requiring a relative or precise order or a secondary on/off to achieve 100%
- Whether to activate the **economical mode** (only for RCL loads), which consists in proportionally reducing the actual light level (and thus the energy consumption) by applying a certain coefficient (20% to 100%), without altering the light levels sent and received through the KNX bus (0% to 100%). The above coefficient does take into account for calculating the actual dimming times, so even if the light level has been reduced by a certain percentage, the time it takes to go from the minimum to the maximum will not be shortened – it will still be the parameterised time.
- The **lowest light level** permitted (0% to 50%), as certain loads may show flickering or behave improperly in particularly low levels. When DIMinBOX DX2 receives a request to dim the load to a value greater than 0% but lower than the parameterised limit, it will apply the level parameterised as minimum.

ETS PARAMETERISATION

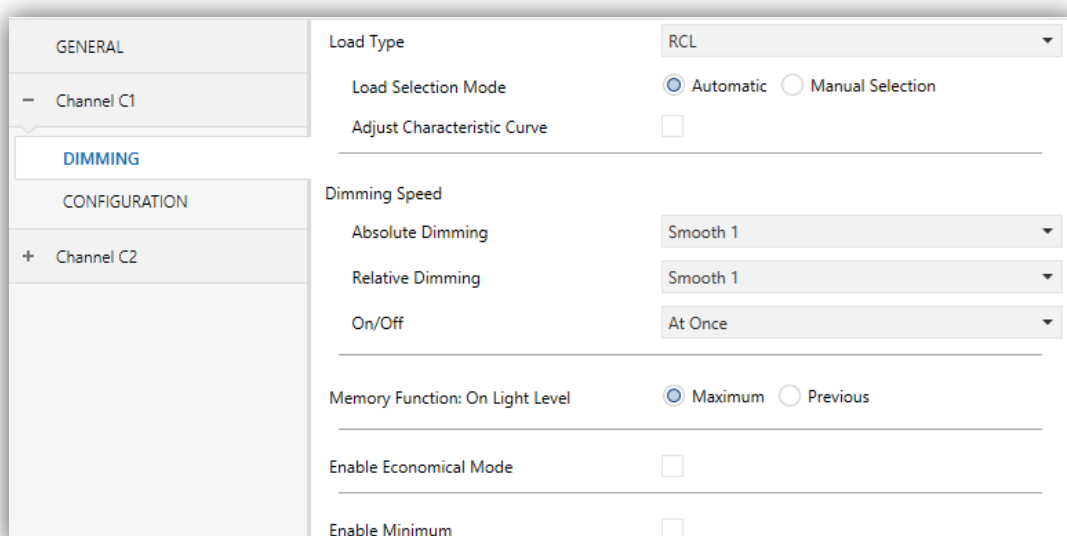

GENERAL	Load Type	RCL
- Channel C1	Load Selection Mode	<input checked="" type="radio"/> Automatic <input type="radio"/> Manual Selection
DIMMING	Adjust Characteristic Curve	<input type="checkbox"/>
CONFIGURATION	Dimming Speed	
+ Channel C2	Absolute Dimming	Smooth 1
	Relative Dimming	Smooth 1
	On/Off	At Once
	Memory Function: On Light Level	<input checked="" type="radio"/> Maximum <input type="radio"/> Previous
	Enable Economical Mode	<input type="checkbox"/>
	Enable Minimum	<input type="checkbox"/>

Figure 5 Channel Cx.

The **Dimming** screen of each channel contains the following parameters:

- **Load Type:** sets the type of the load that will be connected to the output channel. The options are "RCL" (conventional lamps), "CFL" or "LED".

The following two parameters show up in case of selecting "RCL":

- **Load Selection Mode:** "Manual" or "Automatic". And, in case of selecting "Manual":
 - **Type:** "Resistive (R)", "Capacitive (C/C+R)" or "Inductive (L/L+R)".

On the other hand, the following two parameters show up in case of selecting "CFL" or "LED":

- **Dimming Pattern:** "Lineal", "Curve 1" or "Curve 2". Figure 6 shows the different regulation curves for each load type.

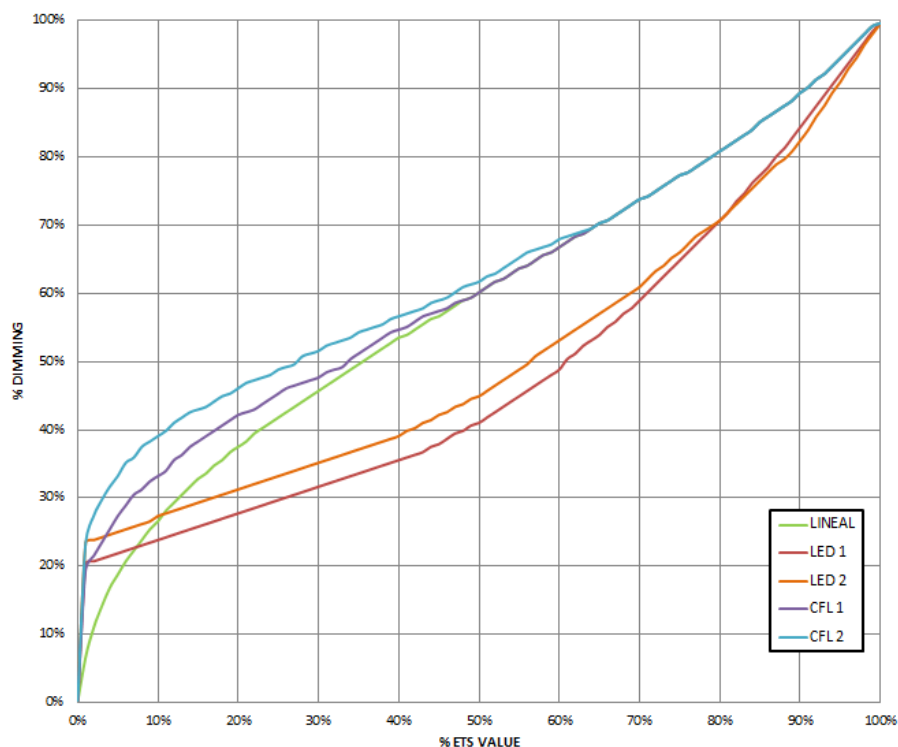

Figure 6 Dimming Patterns for LED and CFL loads.

- **Dimming Mode:** "Trailing Edge" or "Leading Edge".

Important: please configure these options with caution in order to obtain the best results. Refer to section 1.2 for details.

With independence of the load type, the following parameters will be shown:

- **Adjust Characteristic Curve:** see section 2.2.2.
- **Dimming Speed:** sets the type of response (immediate or progressive; see section 2.1) for the different control orders.
 - **Absolute Dimming:** “At Once”, “Smooth 1” or “Smooth 2”.
 - **Relative Dimming:** “At Once”, “Smooth 1” or “Smooth 2”.
 - **On/Off:** “At Once”, “Smooth 1” or “Smooth 2”.
- **Memory Function:** sets the desired response for the switch-on orders: “Maximum” (maximum light level) or “Previous” (previous light level; that is, a “memory” switch-on).
- **Economical Mode:** enables (“Yes”) or disables (“No”) an internal reduction to the light level (and therefore the energy consumption) by a certain coefficient.
 - **Maximum Dimming Value:** 20% to 100%. The lower the maximum dimming value, the greater the consumption reduction.
- **Enable Minimum:** “Yes” or “No”. In case of selecting “Yes”:
 - **Maximum Dimming Value:** 0% to 50%.

On the other hand, the following communication objects will be available:

- **[Cx] On/Off:** one-bit object for the reception of switch orders from the bus. One “1” will switch the light on, while one “0” will switch it off. The dimming speed will be “At Once”, “Smooth 1” or “Smooth 2” according to the parameters, as explained above.
- **[Cx] Absolute Dimming:** 1-byte object for the reception of the desired light level (in terms of percentage) from the bus. Once again, the dimming speed will be “At Once”, “Smooth 1” or “Smooth 2” depending on the parameterisation, as explained above.
- **[Cx] Relative Dimming:** four-bit object for the reception of dimming orders from the bus. The value of the object will be interpreted as the desired step (brighter or darker), according to the KNX standard. The values “0” and “8” interrupt the current regulation.

Value	Response
0x0 (0)	Stop light dimming
0x1 (1)	Decrease the light level by 100%
0x2 (2)	Decrease the light level by 50%
0x3 (3)	Decrease the light level by 25%
0x4 (4)	Decrease the light level by 12%
0x5 (5)	Decrease the light level by 6%
0x6 (6)	Decrease the light level by 3%
0x7 (7)	Decrease the light level by 1%
0x8 (8)	Stop light dimming
0x9 (9)	Increase the light level by 100%
0xA (10)	Increase the light level by 50%
0xB (11)	Increase the light level by 25%
0xC (12)	Increase the light level by 12%
0xD (13)	Increase the light level by 6%
0xE (14)	Increase the light level by 3%
0xF (15)	Increase the light level by 1%

Table 1 Responses to the 4-bit Dimming Orders.

- The dimming speed will be “At Once”, “Smooth 1” or “Smooth 2” depending on the parameterisation, as explained above. **Dimming Speed 1** (provided that **Smooth Dimming Time Objects** has been enabled; see section 2.1): one-byte object that permits decreasing the course time of the “Smooth 1” regulations. Being “T” the parameterised length, any value written to this object will be interpreted as *how much* this T should be decreased. In other words, writing “25%” to this object will speed up the “Smooth 1” progressive regulations by a 25%, making the light regulation last for 75% of the parameterised time.

Value	Effective Dimming Length (T = parameterised time)
0%	T
25%	$\frac{3}{4}$ T
33%	$\frac{2}{3}$ T
50%	$\frac{1}{2}$ T
75%	$\frac{1}{4}$ T
100%	0

Table 2 Dimming Speed object.

- Dimming Speed 2:** analogous to the above object, but for “Smooth 2”.

2.2.2 CHARACTERISTIC CURVE

Although DIMinBOX DX2 provides several pre-set dimming patterns that should fit most luminaires, it is possible to define a custom dimming curve for each channel in order to get a specific response. This curve must be defined in terms of pairs of the form **{control value, dimming value}**, which set the responses required in the luminaire for particular control values.

The response for the intermediate control values is obtained by interpolation.

ETS PARAMETERISATION

Figure 7 Characteristic Curve.

The **Characteristic Curve** screen, once enabled from the Dimming tab (see section 2.2.1), provides the following parameters:

- **Number of Value Pairs:** sets how many pairs of values will define the curve: “2”, “3” or “4”.
- **Minimum Control:** sets the control value (as a percentage) of the first pair. This value is necessarily 1%.
- **Minimum Dimming:** sets the dimming value (as a percentage) of the first pair, i.e., the dimming level to be applied to the luminaire when the device receives a control value that matches the control value of the first pair.
- **Control 1** (only for three-point and four-point curves): sets the control value of the second pair.
- **Dimming 1** (only for three-point and four-point curves): sets the dimming value of the second pair.

- **Control 2** (only for four-point curves): sets the control value of the third pair.
- **Dimming 2** (only for four-point curves): sets the dimming value of the third pair.
- **Maximum Control**: sets the control value of the last pair. This value is necessarily 100%.
- **Minimum Dimming**: sets the dimming value of the last pair.

2.2.3 CONFIGURATION

In addition to the options already described regarding the light dimming function, DIMinBOX DX2 offers some more additional features, which are disabled in parameters by default.

The next sections describe each of them: **status objects**, **custom On/Off** controls, **simple timer**, **flashing**, **scenes and sequences**, **alarm**, **channel lock by object**, **automatic switch-off** and **initialisation settings**.

ETS PARAMETERISATION

The **Configuration** screen allows enabling the following functions for each channel:

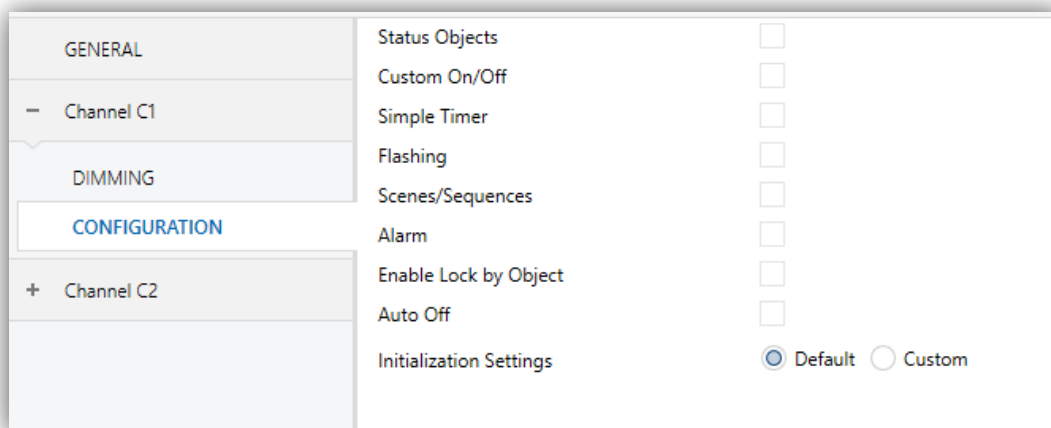

Figure 8 Configuration.

Marking any of the checkboxes will bring **a new entry to the tab tree** for the parameterisation of that particular function (with the exception of “**Enable Lock By Object**”, which has no parameters involved).

One drop-down box is also provided to select the desired **initialisation** of the device ("Default" or "Custom").

The next subsections describe each of the above functions.

2.2.4 STATUS OBJECTS

This function implements, for a particular channel, a one-bit On/Off status object and a one-byte (percentage) status object that will report the channel state at any time, thus informing other devices in the KNX installation.

ETS PARAMETERISATION

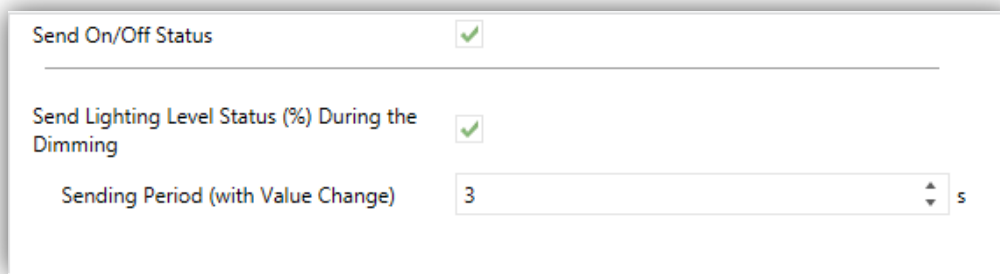

Figure 9 Status Objects.

This **Status Objects** screen contains the following parameters:

- **Send On/Off Status:** enables the "[Cx] On/Off (Status)" one-bit object, which reports the On/Off state of the output channel when it changes. It is always automatically sent back to the bus after the reception of an On/Off order through the analogous control object.
- **Send Lighting Level Status (%):** enables the "[Cx] Lighting Level (Status)" one-byte communication object, which reports –whenever it changes– the status of the light level applied to the output channel in terms of percentage, with an accuracy of $\pm 1\%$. If enabled, the following parameter also shows up:
 - **Sending Period (with Value Change):** sets every how much time the status object should be sent to the bus during a progressive (smooth) dimming, provided that the value differs from the last sent. The available range is 1 to 120 seconds. The default value is 3 seconds.

In case a dimming order is received during either the lock state (see section 2.2.9), an alarm (see section 2.2.10) or an error situation (see section 2.4), these objects will be sent to the bus –provided that they have been enabled– with the same value they already had, to make it evident that the requested order has not been executed.

2.2.5 CUSTOM ON/OFF

This function brings the chance to enable up to two additional On/Off controls for the output channel, and therefore up to two new communication objects to switch the load on or off.

These additional controls allow customising the light level of the output for the “On” and “Off” states and the switch type (at once or smooth).

The custom On/Off function is particularly useful when the dimmer is required to set a specific light level for each room (children bedrooms, hospital rooms, etc.), other than the maximum light level of the normal On/Off control. In such cases, both functions (normal and custom On/Off) can coexist and be used depending on the situation.

ETS PARAMETERISATION

The screenshot displays the configuration interface for two custom On/Off controls. Each control has a checked status indicator (green checkmark) and four adjustable parameters:

- Custom On/Off 1:**
 - Lighting Level at On: 100 %
 - On Type: At Once
 - Lighting Level at Off: 0 %
 - Off Type: At Once
- Custom On/Off 2:**
 - Lighting Level at On: 100 %
 - On Type: At Once
 - Lighting Level at Off: 0 %
 - Off Type: At Once (highlighted in blue)

The Off Type dropdown for Custom On/Off 2 is open, showing three options: At Once (checked with a green checkmark), Smooth 1, and Smooth 2.

Figure 10 Custom On/Off.

Once enabled, the **Custom On/Off** screen offers up to two additional On/Off controls for the channel.

Both can be independently configured through the following parameters:

- **Lighting Level at On:** sets the desired light percentage (10% - 100%) to be applied to the channel when the value "1" is received through the "[Cx] Custom On/Off Y" 1-bit communication object (being "Y" equal to 1 or 2).
- **On Type:** sets the desired dimming type for the custom switch-on of the channel: At once, Smooth 1 or Smooth 2.
- **Lighting Level at Off:** sets the desired light percentage (0% - 50%) to be applied to the corresponding channel when the value "0" is received through the "[Cx] Custom On/Off Y" 1-bit communication object.
- **Off Type:** sets the desired dimming type for the custom switch-off of the channel: At once, Smooth 1 or Smooth 2.

2.2.6 SIMPLE TIMER

This function allows performing a switch-on of the load connected to the channel of DlMinBOX DX2 and a later, automatic (timed) switch-off, being also possible to add delays and to parameterise the time length, the luminosity level and the dimming type. It is also possible to configure the desired effect in case the switch-on trigger is received several times (retriggering).

The timed switch-off can also be triggered in advance through the corresponding object, before the time count ends.

This function is useful in a **motion-dependent light control**, or when the load needs to be switched on and then switched off automatically after a certain time.

ETS PARAMETERISATION

Once enabled, the following parameters can be configured from the **Simple Timer** tab:

Lighting Level at On	100	%
On Delay (0 = No Delay)	0	s
Off Delay (0 = No Delay)	0	s
On Duration (0 = Endless)	0	s
On/Off Type	At Once	
Action in Case of Retriggering	Nothing Nothing ✓ Restart Multiply	

Figure 11 Simple Timer.

- **Lighting Level at On:** sets the desired light percentage (10% - 100%) to be applied when the timed switch-on is triggered (**[Cx] Simple Timer = 1**).
- **On Delay:** sets the time DMinBOX DX2 will wait since the reception of the timed switch-on order and the actual switch-on of the load. The allowed values are: 0 to 3600 s, 0 to 1000 min, 0 to 100h. If no delay is needed, this field should remain at zero.
- **Off Delay:** analogous to the previous parameter, but for the timed switch-off orders (**[Cx] Simple Timer = 0**).
- **On Duration:** sets the time of the “On” stage before the load automatically switches off. Allowed values are: 0 – 3600 s, 0 – 1000 min, 0 – 100h. A value of “0” in this field means that the load should remain on until a contrary order is received.

Note: the time space defined here refers to the entire “On” stage, including (if applicable) the smooth dimming time. In case the dimming is too slow and the “On Duration” time too short, only a partial light transition will take place.

- **On/Off Type:** sets the dimming type to be applied during the timed switch-on and switch-off of the channel: At once, Smooth 1 or Smooth 2.
- **Action in case of Retriggering:**
 - Nothing: successive arrivals of the Timer On order will not reset the timer.
 - Restart: if the output has already been switched on and the On Duration time is counting, the count will be restarted whenever another “1” is received through the “[Cx] Simple Timer” communication object.
 - Multiply: if the output has already been switched on and the On Duration time is counting, then the actual duration will be “n” times the parameterised time, being “n” the number of times the value “1” is received through the “[Cx] Simple Timer” communication object.

The above parameter does not apply to the On and Off Delays:

- If the On (or Off) delay count is running, the timer will NOT be reset even if a new “1” (or “0”) is received through “[Cx] Simple Timer”.

During the simple timing, receiving any other order to regulate the load will interrupt the time count and make DlMinBOX DX2 execute the new request.

2.2.7 FLASHING

This function allows running **On-Off** sequences with customisable lengths (and light levels) for the “On” and the “Off” stages. It is also possible to set the number of repetitions (up to 255, or otherwise endless), as well as the light level of the output after the last repetition (or when an order to interrupt the flashing is received).

The flashing sequence starts when DlMinBOX DX2 receives a “1” through the flashing object and stops once it has executed all the configured repetitions (unless an endless sequence has been parameterised). It is possible to interrupt the flashing sequence at any time by sending one “0” to the flashing object. Sending any other control order (e.g., On/Off, scenes, etc.) will also interrupt it. Also, it is possible to send the device the order to re-start the flashing sequence during the execution.

ETS PARAMETERISATION

Once the function has been enabled, the following parameters can be configured from the **Flashing** screen:

Lighting Level at On	100	%
On Duration	2	s
Off Duration	2	s
Number of Repetitions (0 = Endless)	0	
Final Lighting Level	0	%

Figure 12 Flashing.

- **Lighting Level at On:** sets the desired light percentage (10% - 100%) to be applied to the load during the “On” stages.
- **On Duration:** sets the length of the “On” stages. The available values are 1 to 3600 seconds, 1 to 1000 minutes, 1 to 24 hours (2 seconds by default).

Note: *the time space defined here refers to the entire “On” stage, including (if applicable) the smooth dimming time. In case the dimming is too slow and the “On Duration” time too short, only a partial light transition will take place.*

- **Off Duration:** analogous to the above parameter, but for the “Off” stages.
- **Number of repetitions:** number of times the On/Off cycle will repeat during the sequence (from 0 to 255). For endless flashing, please enter “0”; in such case the sequence will repeat until an order to interrupt it (or any other dimming order: On/Off, scenes, etc.) is received.

Note: *the sequence is triggered by writing the value “1” to object “[Cx] Flashing”, and interrupted by writing the value “0” to the same object.*

- **Final Lighting Level:** sets the desired light percentage (0% - 100%) after the last repetition or after the reception of the value "0" through "[Cx] Flashing".

2.2.8 SCENES/SEQUENCES

This function allows defining up to ten scenes/sequences per channel, which consist in a specific light ambient or dimming sequence than can be triggered by sending the corresponding scene number to the device.

ETS PARAMETERISATION

Each of the ten scenes/sequences can be individually configured from the **Scenes/Sequences** screen.

Scene/Sequence 1	<input type="checkbox"/>
Scene/Sequence 2	<input type="checkbox"/>
Scene/Sequence 3	<input type="checkbox"/>
Scene/Sequence 4	<input type="checkbox"/>
Scene/Sequence 5	<input type="checkbox"/>
Scene/Sequence 6	<input type="checkbox"/>
Scene/Sequence 7	<input type="checkbox"/>
Scene/Sequence 8	<input type="checkbox"/>
Scene/Sequence 9	<input type="checkbox"/>
Scene/Sequence 10	<input type="checkbox"/>

Object to Restart Sequences

- Start/Stop Sequence (Selected)
- None
- Resume/Pause Sequence

Figure 13 Scenes/Sequences.

One checkbox is shown for each of them. Marking any of these checkboxes brings a new entry to the tab tree, from which it is necessary to configure the following fields:

- **Scene/Sequence number:** sets the scene/sequence identifying number (from 1 to 64). The reception of this number (subtracting 1, according to the KNX standard) through the "[Cx] Scenes/Sequences" object will make the controller perform the corresponding actions.

- **Scene/Sequence type:** selects the desired type of response:
 - **Scene:** The scene will consist in setting a certain light level (specified in “**Lighting Level**”) when the “[Cx] Scenes/Sequences” object is received with the proper scene number.

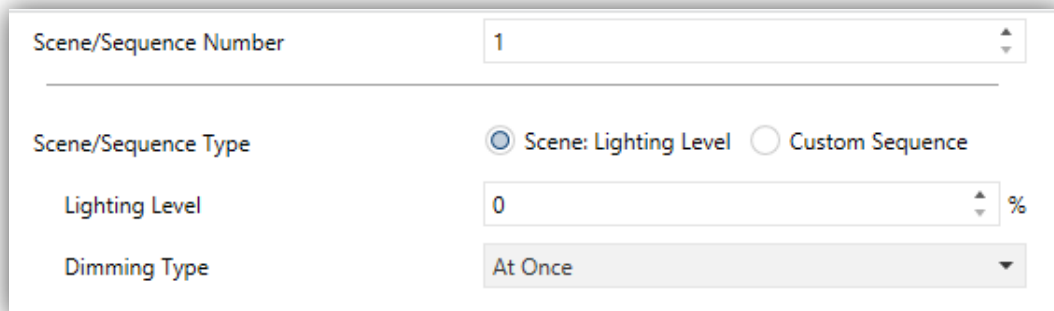

The screenshot shows a configuration window with the following fields:

- Scene/Sequence Number: 1
- Scene/Sequence Type: Scene: Lighting Level Custom Sequence
- Lighting Level: 0 %
- Dimming Type: At Once

Figure 14 Scene.

- **Dimming type:** allows setting whether to apply the new level “At Once”, or progressively (“Smooth 1” or “Smooth 2”).
- **Lighting Level:** brightness level to be applied in the scene.
- **Custom sequence.** The response will consist in a customisable sequence of up to five steps/actions, defined through the following parameters:
 - **Cyclic:** “Yes” will define a cyclic sequence (after the last step, the sequence will start over), while “No” will define a non-cyclic sequence.
 - **Next Scene/Sequence:** this parameter offers the possibility of triggering –after the last step of the sequence– another sequence.
 - **Lighting Level Status Sending:** if set to “Send continuously”, the light level will be sent to the KNX bus through “[Cx] Lighting Level (Status)” during smooth dimming. If set to “Send when sequence ends”, the level will be sent to the bus once the last step of the sequence finishes, even if the sending of the status is enabled or not. In both cases, however, the Status Objects function should have been enabled (see section 2.2.3).

Scene/Sequence Number: 1

Scene/Sequence Type: Scene: Lighting Level Custom Sequence

Cyclic: No Yes

Next Scene/Sequence: None

Lighting Level Status Sending: Send Continuously Send When Sequence Ends

Action 1:

Lighting Level: 0 %

Duration: 2 s

Dimming Type: At Once

Action 2:

Action 3:

Action 4:

Action 5:

Figure 15 Sequence.

For every step (action), the following parameters are required:

- **Lighting Level:** sets the desired luminosity for the step (0% to 100%).
- **Duration:** sets the time length of the step (i.e., the action time). The available values are 1 – 3600 seconds, 1 – 1000 minutes, and 1 – 24 hours (2 seconds by default).

Note: *the time space defined here refers to the entire step action, including (if applicable) the smooth dimming time. In case the dimming is too slow and the step action time too short, only a partial light transition will take place.*

- **Dimming type:** sets the dimming type for the transition between the steps: “At once”, “Smooth 1” or “Smooth 2”.

On the general tab scenes, the configuration of an object to re-start the sequences is possible:

- **None:** Sequence control object disabled.
- **Star/Stop Sequence:** An object named “[Cx] Start/Stop Sequence” is provided in case a sequence needs to be interrupted (value “0”) or re-started (value “1”). If the value “1” is received while no sequence was being run, the last sequence will be triggered again (or the first one parameterised, if no sequences have been executed before).
- **Resume/Pause Sequence:** An object named “[Cx] Resume/Pause Sequence” is provided in case a sequence needs to be interrupted (value “0”) or re-started (value “1”) the sequence from action in which it was paused. If the value “1” is received while no sequence was being run, the last sequence will be triggered again (or the first one parameterised, if no sequences have been executed before).

Note that these objects only apply to sequences, not to static scenes.

Besides running a scene it is also possible to save it: if the device receives an order to save the scene (values 128-191 through “[Cx] Scenes/Sequences”), the current luminosity level of the load (and the dimming speed) will be saved, but only if the value corresponds to any of the parameterised scenes (if not, the order will be ignored).

2.2.9 LOCK CHANNEL

This function permits locking the channel by sending a "1" through a specific one-bit communication object. From that moment, any action being executed by the channel will stop and the load will maintain the brightness value it currently has.

Dimming orders during the lock state will be ignored, while objects common to both channels not implying changes in their light levels will still respond.

DlMinBOX DX2 will unlock the channel when the value "0" arrives through the lock object. The channel will still maintain the same luminosity level: any request received during the lock state will not be run by the channel after the unlock event.

After a power failure, the channel will maintain the lock state and the light level (the **initialization settings** will not apply in this case; see section 2.2.12).

Note that the **Auto Off** (section 2.2.11) function will not be available during the lock.

ETS PARAMETERISATION

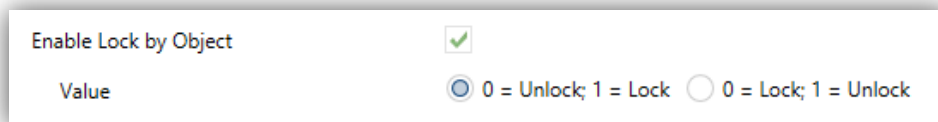

Figure 16. Bloqueo

Enabling this function in the Configuration screen of the channel adds an object (“**[Cx] Lock**”) to the project topology.

According to the polarity of the selected value:

- **0 = Unlock; 1 = Lock**, when this object receives the value “1” the channel will become locked, while the value “0” will resume the normal behaviour.
- **0 = Lock; 1 = Unlock**, when this object receives the value “0” the channel will become locked, while the value “1” will resume the normal behaviour.

2.2.10 ALARMS

This function brings the possibility of configuring an **alarm action** over the output channel, which will be executed on the arrival of a specific trigger object from the bus. Moreover, the activation of the alarm will interrupt any timed action that may be in progress (simple timers, flashing and sequences).

The available alarm actions are: **stopping** the current regulation, **switching the load on** (at a specific, customisable value) and **switching the load off**.

It is possible to **cyclically monitor the alarm object**, and to configure the desired period time. If enabled, the alarm will not only be triggered through the arrival of the designated alarm value through the alarm object, but also in case the no-alarm value is not received at least once within the configured cycle time.

Regarding the **alarm deactivation**, the following actions are available: leaving the load **as is** (no change), **switching the load off**, **switching the load on** (at a specific, customisable value) and switching the load back to the **previous state**. This previous state corresponds to the final lighting level, i.e., the last one before the alarm activation (or the last target level, in case the alarm was triggered in the course of a regulation).

On the other hand, the deactivation can be either normal or frozen (i.e., through an acknowledgement):

- **Normal**: the device leaves the alarm state as soon as the no-alarm value is received.
- **Frozen**: after the arrival of the no-alarm value, an additional acknowledgement object must be received before the device leaves the alarm state.

Any light regulation orders received during the alarm state will be ignored.

After a device power failure, the channel will preserve the alarm state and the light level; any **initial settings** (see section 2.2.12) will not apply in this case.

Note that the **Auto Off** (section 2.2.11) function will not be available during the alarm.

ETS PARAMETERISATION

The screenshot shows a configuration window for alarm settings. It is divided into two main sections: 'Trigger' and 'DEACTIVATION'.
In the 'Trigger' section:
- 'Trigger' is set to radio button '1'.
- 'Cyclical Monitoring Period (0 = Disabled)' is set to '0' with a unit dropdown set to 's'.
- 'Action' is set to 'On'.
- 'Lighting Level' is set to '100 %'.
In the 'DEACTIVATION' section:
- 'Mode' is set to radio button 'Frozen (Acknowledgement Needed)'.
- 'Action' is set to 'No Change'.

Figure 17 Alarm

A specific alarm action can be configured per channel. Once this function has been enabled, the **Alarm** tab shows up:

The parameters involved in the **alarm activation** are:

- **Trigger:** sets which value (0 or 1) will imply the alarm activation when received through the “[Cx] Alarm” object, which will therefore imply the execution of the alarm activation action.
- **Cyclical Monitoring Period:** sets the maximum time without receiving the no-alarm value that will be acceptable prior to automatically triggering the alarm. The available values are 0 to 24 hours, 0 to 14400 minutes, 0 to 3600 seconds, and 0 to 600 tenths of a second. Value “0” disables the alarm cyclical monitor.
- **Action:** sets the desired response to the alarm activation.
 - Stop.
 - On (“**Lighting Level**” allows setting the desired switch-on level).
 - Off.

On the other hand, the parameters involved in the **alarm deactivation** are:

- **Mode:** sets the alarm deactivation procedure:
 - Normal:
 - Frozen (Acknowledgement Needed).

When opting for the second option, object “[Cx] Unfreeze Alarm” will be included into the project topology for the reception of the acknowledgement messages (value “1”).

- **Action:** sets the desired response to the alarm deactivation.
 - No change,
 - On (“**Lighting Level**” allows setting the desired switch-on level),
 - Off,
 - Last (Before Alarm).

2.2.11 AUTO OFF

If the Auto Off function is enabled, the load controlled by the channel will automatically turn off after a certain time with a light level lower than a parameterisable limit.

The Auto Off function counts the time elapsed after the output falls below a certain threshold light level. If this count exceeds the parameterised timeout, DIMinBOX DX2 will turn the load off. The count will stop if an order to increase back the light level over that limit is received.

ETS PARAMETERISATION

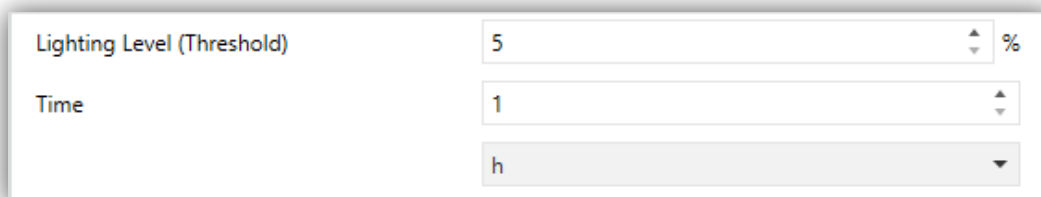

Lighting Level (Threshold)	5	%
Time	1	h

Figure 18. Auto Off.

The only parameters contained by the **Auto Off** screen are:

- **Lighting Level (Threshold):** sets the desired light level (5% to 50%) that will trigger the time count.
- **Time:** sets the time that should elapse before turning the channel off. The available values are 10 to 3600 seconds, 1 to 1000 minutes and 1 to 24 hours.

2.2.12 INITIALISATION

This function is provided to let the integrator specify the desired load state after DIMinBOX DX2 recovers from a KNX bus failure or a power supply failure.

In case the integrator feels comfortable with the **default** initialisation settings (load off after an ETS download, and previous light level after a bus or power supply recovery), it will not be necessary to configure this function.

ETS PARAMETERISATION

If “**Initialisation Settings**” (in the **Configuration** tab; see section 2.2.3) was set to “Custom” a specific entry (“**Initialisation Settings**”) will be added to the tab tree. Otherwise, DMinBOX DX2 will implement the already described default load initialisation.

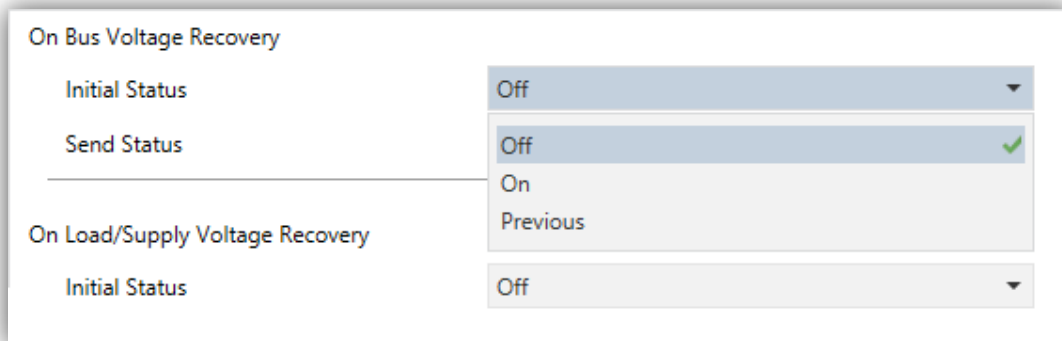

Figure 19 **Initialisation Settings**.

From this new screen, it is possible to set the “**Initial Status**” of the load (both after a bus recovery or a power supply recovery) to either “Off”, “On” or “Previous”.

If the above is set to “On”, then an additional parameter will show up (“**Lighting Level**”) to set the desired light level, in terms of percentage.

2.3 CHANNEL C1+C2

The specific configuration for the two channels in case a **joint channel control** has been configured (see section 2.1) is entirely analogous to the configuration of each independent channel, although in this case both channels will react together and similarly.

Please refer to section 2.2 for details.

2.4 ERROR NOTIFICATIONS

2.4.1 BUS NOTIFICATIONS

Although DIMinBOX DX2 permanently watches for error events and reacts to them to prevent damage in the loads and in the device itself, it can also notify the KNX bus about the occurrence of errors, if such option is set in parameters.

The error situations DIMinBOX DX2 can report are: **short-circuits, overvoltage, overheat, anomalous network frequency, power supply failure** and **wrong load type selection** (in case of having parameterised an RCL load and having manually set a type –resistive, capacitive or inductive– that does not match that of the actual load).

2.4.2 LED INDICATORS

In addition to the above, DIMinBOX DX2 always informs about errors by means of the on-board **LED indicators**. In case of concurrence of multiple errors, DIMinBOX DX2 will only notify about the one with the highest priority – other errors with a lower priority (on whatever channel) will not be notified by the LEDs until the former is over. Nevertheless, if each channel is under a different error, the two of them will be notified through the LEDs, no matter which one has the highest priority.

CHANNEL-DEPENDENT ERRORS	
Short-Circuit Error	
	<p>The two LEDs of the channel blink alternately every 0.5s. After several short-circuits, the device becomes locked and the Prog./Test LED blinks in blue.</p>
Overvoltage Error	
	<p>One of the LEDs of the channel will remain on while the other LED blinks every 0.5s. After several overvoltage errors, the device becomes locked and the Prog./Test LED remains in blue.</p>
Wrong Load Type Error	
	<p>One of the two LEDs of the channel remains on while the other one blinks rapidly.</p>

CHANNEL-INDEPENDENT ERRORS	
Overheating Error	
	All the four LEDs remain on.
Power Supply Failure Error	
	Two LEDs (one per channel) blink together every second.
Anomalous Network Frequency Error	
	The four LEDs blink in a stair-shaped sequence every 0.5 seconds.

Table 3 Error Notification through the on-board LEDs.

2.4.3 REACTION TO ERRORS

For safety reasons and with independence of the bus notifications, DIMinBOX DX2 always takes an action when an error is detected.

Note that when this action implies disconnecting the load, DIMinBOX DX2 will no longer perform timed actions nor be aware of short-circuit, overvoltage or wrong load type situations, although other errors will still be monitored.

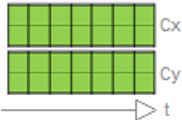
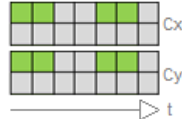
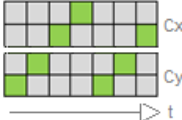
In the case of multiple errors happening at the same time, DIMinBOX DX2 will focus on the error with a higher priority (see Table 3), which is supposed to trigger a more restrictive response action.

- **Short Circuit:** when a short circuit takes place, DIMinBOX DX2 disconnects the load and waits until a new dimming command is received. When that happens, it will simply try to dim the load and will repeat the process if a new short circuit is detected.

In case of more than **three short circuits in less than two minutes** time (without resetting the device), DIMinBOX DX2 will remain **locked** for three minutes and ignore any dimming order addressed to that channel. The lock status will be notified to the KNX bus (if configured in parameters), and also by a blue intermittence of the Prog./Test LED.

- **Overvoltage:** when an overvoltage situation takes place, DIMinBOX DX2 disconnects the load and waits until a new dimming command is received. When that happens, it will simply try to dim the load and will repeat the process if a new overvoltage is detected.

In case of more than **three overvoltages in less than two minutes** time (without resetting the device), DIMinBOX DX2 will remain **locked** for three minutes and ignore any dimming order addressed to that channel. The lock status will be notified to the KNX bus (if configured in parameters), and also by leaving the Prog./Test LED turned on in blue colour.

- **Overheat:**
 - When the internal temperature of DIMinBOX DX2 results to be **between 65°C and 75°C**, the device will lower the light level of the channels to 20%, ignoring later orders to increase the level. Once the temperature is lower than 73°C, the device will resume the normal behaviour, although the light level will remain as is until a new dimming order is received.
 - When the internal temperature results to be **over 75°C**, the device will completely disconnect both channels and switch the loads off, ignoring all orders to dim the light. When the temperature falls below 73°C, the device will resume the normal behaviour, although the light level will remain as is until a new order is received.
 - In addition to the above, DIMinBOX DX2 is equipped with an **automatically resettable fuse**, which provides extra protection to the circuitry. Under situations of abnormally high temperature that cannot be solved by disconnecting the loads, this fuse will blow out, thus interrupting all communications and turning DIMinBOX DX2 completely off.
- **Power Supply Failure:** when DIMinBOX DX2 detects a drop of the power supply, it disconnects both channels and waits until it recovers. Whether the channels should remain off (or at a certain level) after the power recovery or recover their previous light levels can be parameterised (see section 2.2.12).
- **Anomalous Frequency:** when DIMinBOX DX2 detects an abnormal frequency in the power network, it will react analogously as for the Power

Supply Failure. During the anomalous frequency error, the device will still be able to detect overheating and drops of the power supply.

- **Wrong Load Type:** under either a non-conventional load type configuration or a manual configuration of a specific conventional (RCL) load type, in case DIMinBOX DX2 tries to regulate the load and detects any issues due to a mismatch in the load type configuration, it will disconnect the output channel and wait for new dimming orders. When they arrive, it will try to dim the load and will repeat the process if the load type is still wrong.

ETS PARAMETERISATION

If error notifications have been enabled from the **General** tab (see section 2.1), an additional entry will be shown in the tab tree on the left.

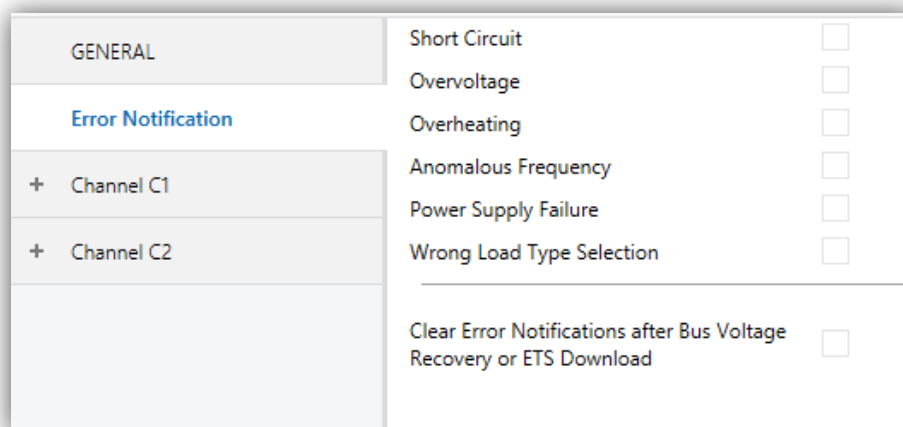

Figure 20 Error Notification.

This screen contains one checkbox per error situation (including “**Wrong Load Type Selection**”, in case of parameterising either a specific conventional load or a non-conventional load type). Marking any of them will add a specific one-bit communication object to the project topology (or two, if the error is channel-dependent but a two-channel control has been configured).

The specific error objects are:

- **Power Supply Fault,**
- **[Cx] Short Circuit,**

- **Overheating,**
- **[Cx] Overvoltage,**
- **Anomalous Frequency.**
- **[Cx] Wrong Load Type Parameterization.**

These objects are sent periodically sent to the bus (every thirty seconds) with a value of “1” as long as the error persists. Once the undesired situation is over, they are sent (once) with the value “0”. Note that, as already explained, if several errors take place at the same time, the error with the highest priority may mask other errors, which therefore will not be reported until the former is solved.

There is also a secondary object related to some of the error situations:

- **[Cx] Lock Due to Overvoltages.**
- **[Cx] Lock Due to Short Circuits.**

When DIMinBOX DX2 gets automatically locked after detecting one of these errors multiple times, the lock object corresponding to that error will be sent with value “1”. Once the lock state is over, it will be sent with value “0”.

Back to the parameters, one more is shown in addition to the above checkboxes:

- **Clear Error Notifications after Bus Voltage Recovery or ETS Download:**
sets whether the previous state of the enabled error objects should be cleared during the start-up of the device (i.e., whether they should be sent with the value “0” to the KNX bus).

This does not mean that DIMinBOX DX2 will ignore any errors still taking place after the device start-up (in such case, the corresponding object will be sent with the value “1” after being sent with the value “0”), but may be useful to *force* all error states to zero in the beginning, to update other devices in the KNX installation.

2.5 INPUTS

DIMinBOX DX2 incorporates **two analogue/digital inputs**, each configurable as a:

- **Binary Input**, for the connection of a pushbutton or a switch/sensor.
- **Temperature Probe**, for the connection of a temperature sensor (such as models ZN1AC-NTC68 S/E/F and SQ-AmbienT from Zennio).
- **Motion Detector**, for the connection of a motion detector (model ZN1IO-DETEC-P from Zennio).

Important: *older models of the Zennio motion detector (e.g., ZN1IO-DETEC and ZN1IO-DETEC-N) will not work properly with DIMinBOX DX2.*

ETS PARAMETERISATION

When **Inputs** has been activated in the general configuration screen (see section 2.1), the following drop-down lists will be available for the selection of the specific functions required.

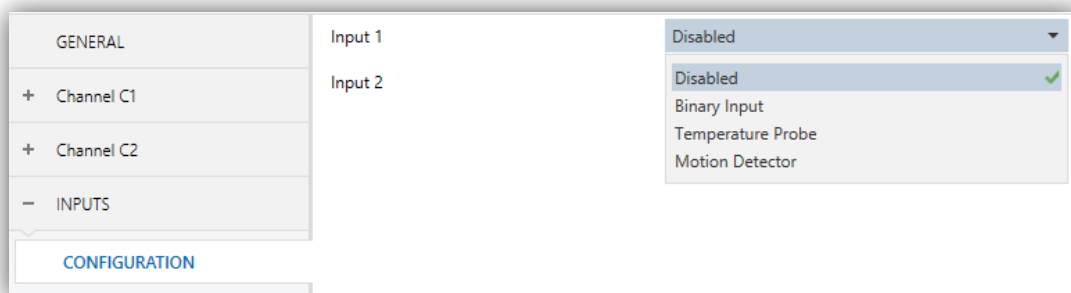

Figure 21. Inputs - Configuration

All inputs are disabled by default. Depending on the function selected for each input, additional tabs will be included in the menu on the left.

2.5.1 BINARY INPUT

Please refer to the “**Binary Inputs**” user manual, available in the DIMinBOX DX2 product section at the Zennio homepage, www.zennio.com.

2.5.2 TEMPERATURE PROBE

Please refer to the “**Temperature Probe**” user manual, available in the DIMinBOX DX2 product section at the Zennio homepage, www.zennio.com.

2.5.3 MOTION DETECTOR

It is possible to connect motion detectors (models **ZN1IO-DETEC-P** and **ZN1IO-DETEC-X** from Zennio) to the input ports of DIMinBOX DX2. This brings the device with the possibility of monitoring motion and presence in the room, as well as the light level. Depending on the detection, different response actions can be parameterised.

Please refer to the specific user manual “**Motion Detector**” (available in the DIMinBOX DX2 product section at the Zennio homepage, www.zennio.com) for detailed information about the functionality and the configuration of the related parameters.

Notes:

- The ZN1IO-DETEC-P motion detector is compatible with a variety of Zennio devices. However, depending on the device it is actually being connected to, the functionality may differ slightly. Therefore, please refer specifically to the aforementioned user manual.
- Motion detectors with references ZN1IO-DETEC and ZN1IO-DETEC-N are **not compatible** with DIMinBOX DX2 (may report inaccurate measurements if connected to this device).
- When connected to DIMinBOX DX2, the rear micro-switch of model ZN1IO-DETEC-P should be set to position “**Type B**”.

2.6 LOGIC FUNCTIONS

This module makes it possible to perform numeric and binary operations to incoming values received from the KNX bus, and to send the results through other communication objects specifically enabled for this purpose.

DlMinBOX DX2 can implement **up to 10 different and independent functions**, each of them entirely customisable and consisting in **up to 4 consecutive operations each**.

The execution of each function can depend on a configurable **condition**, which will be evaluated every time the function is **triggered** through specific, parameterisable communication objects. The result after executing the operations of the function can also be evaluated according to certain **conditions** and afterwards sent (or not) to the KNX bus, which can be done every time the function is executed, periodically or only when the result differs from the last one.

Please refer to the specific user manual “**Logic Functions**” (available in the DlMinBOX DX2 product section at the Zennio homepage, www.zennio.com) for detailed information about the functionality and the configuration of the related parameter.

2.7 MANUAL CONTROL

The two output channels of DIMinBOX DX2 can be manually operated and verified by means of the **on-board pushbuttons and LEDs** (two per channel), located on the top side of the device.

Two alternative approaches are provided for this manual control:

- **Test On Mode**, intended for testing the installation and the loads while setting up the device.
- **Test Off Mode**, intended for any other purposes during normal, long-term operation of the device.

ETS lets configuring **which of the two modes** (if not both) should be accessible. Moreover, a specific **object** can also be enabled in parameters in order to lock/unlock the manual control in runtime (to prevent undesired use, for example).

The **Test Off Mode is active any time** (unless disabled in parameters), which means that the on-board pushbuttons will work according to this mode by default.

On the other hand, **switching to the Test On Mode** (unless disabled in parameters) is done by holding the Prog/Test button for at least three seconds. This will turn the LED yellow. Once the button is released, the LED will become green (which means the Test On Mode is now active). Pressing the button again will turn the LED off, which will mean the Test Off Mode has become the active mode again

In case of having parameterised a joint control of both channels, only the pushbuttons of channel C1 will have effect (on both channels, in this case).

Note: *both manual control modes come enabled from factory.*

2.7.1 TEST ON MODE

Under this mode, the output channels will be controllable only by means of the manual control itself. Any orders received from the KXN bus will be ignored, and the status objects will not be sent to the bus either.

The error notification, lock and timed functions will remain inoperative as well. On the other hand, the **Economical mode** and the **Minimum Light Level** will still apply,

Note that, for safety reasons, the Test On Mode will not be accessible while there are errors in any of the channels (see section 2.4). On the other hand, if an error is detected during the Test On Mode, the device will automatically leave this mode.

Regarding the loads themselves, their reaction to the **short and long presses** will be as follows:

- **Short press:** the load will switch on or off, depending on the button.
- **Long press:** depending on the button, the load will keep progressively increasing or decreasing the light level until the button is released. The speed of this regulation will be the one that has been parameterised in ETS for the relative dimming.

2.7.2 TEST OFF MODE

Operating the manual control under this mode will be entirely analogous as receiving orders from the KNX bus. In fact, the device will still respond to any requests from the bus and will send the status objects when corresponding.

Under the Test Off Mode, the loads react to the **short and long presses** the same way they do in the Test On Mode:

- **Short press:** the load will switch on or off, depending on the button.
- **Long press:** depending on the button, the load will keep progressively increasing or decreasing the light level until the button is released. The speed of this regulation will be the one that has been parameterised in ETS for the relative dimming.

ANNEX I: COMMUNICATION OBJECTS

“Functional range” shows the values that, with independence of any other values permitted by the bus according to the object size, may be of any use or have a particular meaning because of the specifications or restrictions from both the KNX standard or the application program itself.

Number	Size	I/O	Flags	Data type (DPT)	Functional Range	Name	Function
1	1 Bit	I	C - - W -	DPT_Switch	0/1	[C1] On/Off	0 = Off; 1 = On
	1 Bit	I	C - - W -	DPT_Switch	0/1	[C1+C2] On/Off	0 = Off; 1 = On
2	1 Bit	I	C - - W -	DPT_Switch	0/1	[C2] On/Off	0 = Off; 1 = On
3	4 Bit	I	C - - W -	DPT_Control_Dimming	0x0 (Stop) 0x1 (Dec. by 100%) 0x2 (Dec. by 50%) 0x3 (Dec. by 25%) 0x4 (Dec. by 12%) 0x5 (Dec. by 6%) 0x6 (Dec. by 3%) 0x7 (Dec. by 1%) 0x8 (Stop) 0x9 (Inc. by 100%) 0xA (Inc. by 50%) 0xB (Inc. by 25%) 0xC (Inc. by 12%) 0xD (Inc. by 6%) 0xE (Inc. by 3%) 0xF (Inc. by 1%)	[C1] Relative Dimming	4 bits dimmer ctrl
	4 Bit	I	C - - W -	DPT_Control_Dimming	0x0 (Stop) 0x1 (Dec. by 100%) ... 0x8 (Stop) 0x9 (Inc. by 100%) ... 0xF (Inc. by 1%)	[C1+C2] Relative Dimming	4 bits dimmer ctrl
4	4 Bit	I	C - - W -	DPT_Control_Dimming	0x0 (Stop) 0x1 (Dec. by 100%) ... 0x8 (Stop) 0x9 (Inc. by 100%) ... 0xF (Inc. by 1%)	[C2] Relative Dimming	4 bits dimmer ctrl
5	1 Byte	I	C - - W -	DPT_Scaling	0% - 100%	[C1] Absolute Dimming	1 byte dimmer ctrl

	1 Byte	I	C - - W -	DPT_Scaling	0% - 100%	[C1+C2] Absolute Dimming	1 byte dimmer ctrl
6	1 Byte	I	C - - W -	DPT_Scaling	0% - 100%	[C2] Absolute Dimming	1 byte dimmer ctrl
7	2 Bytes	I/O	C - R W -	DPT_TimePeriodSec	0-65535	Smooth Dimming Time 1	Time in Seconds
8	2 Bytes	I/O	C - R W -	DPT_TimePeriodSec	0-65535	Smooth Dimming Time 2	Time in Seconds
11	1 Bit	O	C T R - -	DPT_Alarm	0/1	Power Supply Failure	0 = No error; 1 = Error
12	1 Bit	O	C T R - -	DPT_Alarm	0/1	[C1] Short Circuit	0 = No error; 1 = Error
	1 Bit	O	C T R - -	DPT_Alarm	0/1	[C1+C2] Short Circuit	0 = No error; 1 = Error
13	1 Bit	O	C T R - -	DPT_Alarm	0/1	[C2] Short Circuit	0 = No error; 1 = Error
14	1 Bit	O	C T R - -	DPT_Alarm	0/1	[C1] Lock Due to Short Circuits	0 = Unlocked; 1 = Locked
	1 Bit	O	C T R - -	DPT_Alarm	0/1	[C1+C2] Lock Due to Short Circuits	0 = Unlocked; 1 = Locked
15	1 Bit	O	C T R - -	DPT_Alarm	0/1	[C2] Lock Due to Short Circuits	0 = Unlocked; 1 = Locked
16	1 Bit	O	C T R - -	DPT_Alarm	0/1	Overheating	0 = No error; 1 = Error
17	1 Bit	O	C T R - -	DPT_Alarm	0/1	[C1] Overvoltage	0 = No error; 1 = Error
	1 Bit	O	C T R - -	DPT_Alarm	0/1	[C1+C2] Overvoltage	0 = No error; 1 = Error
18	1 Bit	O	C T R - -	DPT_Alarm	0/1	[C2] Overvoltage	0 = No error; 1 = Error
19	1 Bit	O	C T R - -	DPT_Alarm	0/1	[C1] Lock Due to Overvoltages	0 = Unlocked; 1 = Locked
	1 Bit	O	C T R - -	DPT_Alarm	0/1	[C1+C2] Lock Due to Overvoltages	0 = Unlocked; 1 = Locked
20	1 Bit	O	C T R - -	DPT_Alarm	0/1	[C2] Lock Due to Overvoltages	0 = Unlocked; 1 = Locked
21	1 Bit	O	C T R - -	DPT_Alarm	0/1	Anomalous Frequency	0 = No error; 1 = Error
22	1 Bit	O	C T R - -	DPT_Alarm	0/1	[C1] Load Type Parameterization Error	0 = No error; 1 = Error
	1 Bit	O	C T R - -	DPT_Alarm	0/1	[C1+C2] Load Type Parameterization Error	0 = No error; 1 = Error
23	1 Bit	O	C T R - -	DPT_Alarm	0/1	[C2] Load Type Parameterization Error	0 = No error; 1 = Error
24	1 Bit	O	C T R - -	DPT_Switch	0/1	[C1] On/Off (Status)	0 = Off; 1 = On
	1 Bit	O	C T R - -	DPT_Switch	0/1	[C1+C2] On/Off (Status)	0 = Off; 1 = On
25	1 Bit	O	C T R - -	DPT_Switch	0/1	[C2] On/Off (Status)	0 = Off; 1 = On
26	1 Byte	O	C T R - -	DPT_Scaling	0% - 100%	[C1] Lighting Level (Status)	0 - 100%
	1 Byte	O	C T R - -	DPT_Scaling	0% - 100%	[C1+C2] Lighting Level (Status)	0 - 100%
27	1 Byte	O	C T R - -	DPT_Scaling	0% - 100%	[C2] Lighting Level (Status)	0 - 100%
28	1 Bit	I	C - - W -	DPT_Switch	0/1	[C1] Custom On/Off 1	0 = Off; 1 = On
	1 Bit	I	C - - W -	DPT_Switch	0/1	[C1+C2] Custom On/Off 1	0 = Off; 1 = On
29	1 Bit	I	C - - W -	DPT_Switch	0/1	[C2] Custom On/Off 1	0 = Off; 1 = On
30	1 Bit	I	C - - W -	DPT_Switch	0/1	[C1] Custom On/Off 2	0 = Off; 1 = On
	1 Bit	I	C - - W -	DPT_Switch	0/1	[C1+C2] Custom On/Off 2	0 = Off; 1 = On
31	1 Bit	I	C - - W -	DPT_Switch	0/1	[C2] Custom On/Off 2	0 = Off; 1 = On
32	1 Bit	I	C - - W -	DPT_Start	0/1	[C1] Simple Timer	0 = Deactivate; 1 = Activate
	1 Bit	I	C - - W -	DPT_Start	0/1	[C1+C2] Simple Timer	0 = Deactivate; 1 = Activate
33	1 Bit	I	C - - W -	DPT_Start	0/1	[C2] Simple Timer	0 = Deactivate; 1 = Activate

34	1 Bit	I	C - - W -	DPT_Start	0/1	[C1] Flashing	0 = Deactivate; 1 = Activate
	1 Bit	I	C - - W -	DPT_Start	0/1	[C1+C2] Flashing	0 = Deactivate; 1 = Activate
35	1 Bit	I	C - - W -	DPT_Start	0/1	[C2] Flashing	0 = Deactivate; 1 = Activate
36	1 Byte	I	C - - W -	DPT_SceneControl	0-63; 128-191	[C1] Scenes/Sequences	Scene/Sequence value
	1 Byte	I	C - - W -	DPT_SceneControl	0-63; 128-191	[C1+C2] Scenes/Sequences	Scene/Sequence value
37	1 Byte	I	C - - W -	DPT_SceneControl	0-63; 128-191	[C2] Scenes/Sequences	Scene/Sequence value
38	1 Bit	I	C - - W -	DPT_Start	0/1	[C1] Start/Stop Sequence	0 = Stop; 1 = Start
	1 Bit	I	C - - W -	DPT_Start	0/1	[C1+C2] Start/Stop Sequence	0 = Stop; 1 = Start
	1 Bit	I	C - - W -	DPT_Start	0/1	[C1] Resume/Pause Sequence	0 = Pause; 1 = Resume
	1 Bit	I	C - - W -	DPT_Start	0/1	[C1+C2] Resume/Pause Sequence	0 = Pause; 1 = Resume
39	1 Bit	I	C - - W -	DPT_Start	0/1	[C2] Start/Stop Sequence	0 = Stop; 1 = Start
	1 Bit	I	C - - W -	DPT_Start	0/1	[C2] Resume/Pause Sequence	0 = Pause; 1 = Resume
40	1 Bit	I/O	C - R W -	DPT_Enable	0/1	[C1] Lock	0 = Unlock; 1 = Lock
	1 Bit	I/O	C - R W -	DPT_Enable	0/1	[C1+C2] Lock	0 = Unlock; 1 = Lock
	1 Bit	I/O	C - R W -	DPT_Enable	0/1	[C1] Lock	0 = Lock; 1 = Unlock
	1 Bit	I/O	C - R W -	DPT_Enable	0/1	[C1+C2] Lock	0 = Lock; 1 = Unlock
41	1 Bit	I/O	C - R W -	DPT_Enable	0/1	[C2] Lock	0 = Unlock; 1 = Lock
	1 Bit	I/O	C - R W -	DPT_Enable	0/1	[C2] Lock	0 = Lock; 1 = Unlock
42	1 Bit	I/O	C - R W -	DPT_Enable	0/1	Lock manual control	0 = Unlock; 1 = Lock
	1 Bit	I/O	C - R W -	DPT_Enable	0/1	Lock manual control	0 = Lock; 1 = Unlock
43	1 Byte	I	C - - W -	20.xxx	0/1/2	[C1] Edge Select (Only for Test Purposes)	0 = Automatic; 1 = Leading; 2 = Trailing
	1 Byte	I	C - - W -	20.xxx	0/1/2	[C1+C2] Edge Select (Only for Test Purposes)	0 = Automatic; 1 = Leading; 2 = Trailing
44	1 Byte	I	C - - W -	20.xxx	0/1/2	[C2] Edge Select (Only for Test Purposes)	0 = Automatic; 1 = Leading; 2 = Trailing
45	1 Byte	I	C - - W -	Dimming_Pattern_Non-standard DPT	0/1/2	[C1] Dimming Pattern (Only for Test Purposes)	0 = Linear; 1 = Curve 1; 2 = Curve 2
	1 Byte	I	C - - W -	Dimming_Pattern_Non-standard DPT	0/1/2	[C1+C2] Dimming Pattern (Only for Test Purposes)	0 = Linear; 1 = Curve 1; 2 = Curve 2
46	1 Byte	I	C - - W -	Dimming_Pattern_Non-standard DPT	0/1/2	[C2] Dimming Pattern (Only for Test Purposes)	0 = Linear; 1 = Curve 1; 2 = Curve 2
47	1 Bit	I	C - - W -	DPT_Alarm	0/1	[C1] Alarm	0 = Normal; 1 = Alarm
	1 Bit	I	C - - W -	DPT_Alarm	0/1	[C1] Alarm	0 = Alarm; 1 = Normal
	1 Bit	I	C - - W -	DPT_Alarm	0/1	[C1+C2] Alarm	0 = Normal; 1 = Alarm
	1 Bit	I	C - - W -	DPT_Alarm	0/1	[C1+C2] Alarm	0 = Alarm; 1 = Normal
48	1 Bit	I	C - - W -	DPT_Alarm	0/1	[C2] Alarm	0 = Normal; 1 = Alarm
	1 Bit	I	C - - W -	DPT_Alarm	0/1	[C2] Alarm	0 = Alarm; 1 = Normal
49	1 Bit	I	C - - W -	DPT_Trigger	0/1	[C1] Unfreeze Alarm	Alarm = 0 + Unfreeze = 1 => End Alarm
	1 Bit	I	C - - W -	DPT_Trigger	0/1	[C1+C2] Unfreeze Alarm	Alarm = 0 + Unfreeze = 1 => End Alarm
	1 Bit	I	C - - W -	DPT_Trigger	0/1	[C1] Unfreeze Alarm	Alarm = 1 + Unfreeze = 1 => End Alarm
	1 Bit	I	C - - W -	DPT_Trigger	0/1	[C1+C2] Unfreeze Alarm	Alarm = 1 + Unfreeze = 1 => End Alarm

50	1 Bit	I	C - - W -	DPT_Trigger	0/1	[C2] Unfreeze Alarm	Alarm = 0 + Unfreeze = 1 => End Alarm
	1 Bit	I	C - - W -	DPT_Trigger	0/1	[C2] Unfreeze Alarm	Alarm = 1 + Unfreeze = 1 => End Alarm
51	1 Byte	I	C - - W -	DPT_Scaling	0% - 100%	[C1+C2] Minimum Dimming Value (Only for Test Purposes)	0 - 50%
	1 Byte	I	C - - W -	DPT_Scaling	0% - 100%	[C1] Minimum Dimming Value (Only for Test Purposes)	0 - 50%
52	1 Byte	I	C - - W -	DPT_Scaling	0% - 100%	[C2] Minimum Dimming Value (Only for Test Purposes)	0 - 50%
53, 57	2 Bytes	O	C T R - -	DPT_Value_Temp	-273.00 - 670760.00	[Ix] Current Temperature	Temperature sensor value
54, 58	1 Bit	O	C T R - -	DPT_Alarm	0/1	[Ix] Overcooling	0 = No Alarm; 1 = Alarm
55, 59	1 Bit	O	C T R - -	DPT_Alarm	0/1	[Ix] Overheating	0 = No Alarm; 1 = Alarm
56, 60	1 Bit	O	C T R - -	DPT_Alarm	0/1	[Ix] Probe Error	0 = No Alarm; 1 = Alarm
61, 67	1 Bit	I	C - - W -	DPT_Switch	0/1	[Ix] Input Lock	1 = Locked; 0 = Unlocked
62, 68	1 Bit		C T - - -	DPT_Switch	0/1	[Ix] [Short Press] 0	Sending of 0
	1 Bit		C T - - -	DPT_Switch	0/1	[Ix] [Short Press] 1	Sending of 1
	1 Bit	I	C T - W -	DPT_Switch	0/1	[Ix] [Short Press] 0/1 Switching	Switching 0/1
	1 Bit		C T - - -	DPT_UpDown	0/1	[Ix] [Short Press] Move Up Shutter	Sending of 0 (Up)
	1 Bit		C T - - -	DPT_UpDown	0/1	[Ix] [Short Press] Move Down Shutter	Sending of 1 (Down)
	1 Bit		C T - - -	DPT_UpDown	0/1	[Ix] [Short Press] Move Up/Down Shutter	Switching 0/1 (Up/Down)
	1 Bit		C T - - -	DPT_Step	0/1	[Ix] [Short Press] Stop/Step Up Shutter	Sending of 0 (Stop/Step Up)
	1 Bit		C T - - -	DPT_Step	0/1	[Ix] [Short Press] Stop/Step Down Shutter	Sending of 1 (Stop/Step Down)
	1 Bit		C T - - -	DPT_Step	0/1	[Ix] [Short Press] Stop/Step Shutter (Switched)	Switching of 0/1 (Stop/Step Up/Down)
	4 Bit		C T - - -	DPT_Control_Dimming	0x0 (Stop) 0x1 (Dec. by 100%) ... 0x8 (Stop) 0x9 (Inc. by 100%) ... 0xF (Inc. by 1%)	[Ix] [Short Press] Brighter	Increase Brightness
	4 Bit		C T - - -	DPT_Control_Dimming	0x0 (Stop) 0x1 (Dec. by 100%) ... 0x8 (Stop) 0x9 (Inc. by 100%) ... 0xF (Inc. by 1%)	[Ix] [Short Press] Darker	Decrease Brightness
	4 Bit		C T - - -	DPT_Control_Dimming	0x0 (Stop) 0x1 (Dec. by 100%) ... 0x8 (Stop) 0x9 (Inc. by 100%)	[Ix] [Short Press] Brighter/Darker	Switch Bright/Dark

				...			
	1 Bit		CT---	DPT_Switch	0/1	[Ix] [Short Press] Dimmer ON	Sending of 1 (ON)
	1 Bit		CT---	DPT_Switch	0/1	[Ix] [Short Press] Dimmer OFF	Sending of 0 (OFF)
	1 Bit	I	CT-W-	DPT_Switch	0/1	[Ix] [Short Press] Dimmer ON/OFF	Switching 0/1
	1 Byte		CT---	DPT_SceneControl	0-63; 128-191	[Ix] [Short Press] Run Scene	Sending of 0 - 63
	1 Byte		CT---	DPT_SceneControl	0-63; 128-191	[Ix] [Short Press] Save Scene	Sending of 128 - 191
	1 Bit	I/O	CTRW-	DPT_Switch	0/1	[Ix] [Switch/Sensor] Edge	Sending of 0 or 1
	1 Byte		CT---	DPT_Value_1_Ucount	0 - 255	[Ix] [Short Press] Constant Value (Integer)	0 - 255
	1 Byte		CT---	DPT_Scaling	0% - 100%	[Ix] [Short Press] Constant Value (Percentage)	0% - 100%
	2 Bytes		CT---	DPT_Value_2_Ucount	0 - 65535	[Ix] [Short Press] Constant Value (Integer)	0 - 65535
	2 Bytes		CT---	9.xxx	-671088.64 - 670760.96	[Ix] [Short Press] Constant Value (Float)	Float value
63, 69	1 Byte	I	C--W-	DPT_Scaling	0% - 100%	[Ix] [Short Press] Shutter Status (Input)	0% = Top; 100% = Bottom
	1 Byte	I	C--W-	DPT_Scaling	0% - 100%	[Ix] [Short Press] Dimming Status (Input)	0% - 100%
64, 70	1 Bit		CT---	DPT_Switch	0/1	[Ix] [Long Press] 0	Sending of 0
	1 Bit		CT---	DPT_Switch	0/1	[Ix] [Long Press] 1	Sending of 1
	1 Bit	I	CT-W-	DPT_Switch	0/1	[Ix] [Long Press] 0/1 Switching	Switching 0/1
	1 Bit		CT---	DPT_UpDown	0/1	[Ix] [Long Press] Move Up Shutter	Sending of 0 (Up)
	1 Bit		CT---	DPT_UpDown	0/1	[Ix] [Long Press] Move Down Shutter	Sending of 1 (Down)
	1 Bit		CT---	DPT_UpDown	0/1	[Ix] [Long Press] Move Up/Down Shutter	Switching 0/1 (Up/Down)
	1 Bit		CT---	DPT_Step	0/1	[Ix] [Long Press] Stop/Step Up Shutter	Sending of 0 (Stop/Step Up)
	1 Bit		CT---	DPT_Step	0/1	[Ix] [Long Press] Stop/Step Down Shutter	Sending of 1 (Stop/Step Down)
	1 Bit		CT---	DPT_Step	0/1	[Ix] [Long Press] Stop/Step Shutter (Switched)	Switching of 0/1 (Stop/Step Up/Down)
	4 Bit		CT---	DPT_Control_Dimming	0x0 (Stop) 0x1 (Dec. by 100%) ... 0x8 (Stop) 0x9 (Inc. by 100%) ... 0xF (Inc. by 1%)	[Ix] [Long Press] Brighter	Long Pr. -> Brighter; Release -> Stop
	4 Bit		CT---	DPT_Control_Dimming	0x0 (Stop) 0x1 (Dec. by 100%) ... 0x8 (Stop) 0x9 (Inc. by 100%) ...	[Ix] [Long Press] Darker	Long Pr. -> Darker; Release -> Stop

					0xF (Inc. by 1%)		
	4 Bit		CT----	DPT_Control_Dimming	0x0 (Stop) 0x1 (Dec. by 100%) ... 0x8 (Stop) 0x9 (Inc. by 100%) ... 0xF (Inc. by 1%)	[Ix] [Long Press] Brighter/Darker	Long Pr. -> Brighter/Darker; Release -> Stop
	1 Bit		CT----	DPT_Switch	0/1	[Ix] [Long Press] Dimmer ON	Sending of 1 (ON)
	1 Bit		CT----	DPT_Switch	0/1	[Ix] [Long Press] Dimmer OFF	Sending of 0 (OFF)
	1 Bit	I	CT-W-	DPT_Switch	0/1	[Ix] [Long Press] Dimmer ON/OFF	Switching 0/1
	1 Byte		CT----	DPT_SceneControl	0-63; 128-191	[Ix] [Long Press] Run Scene	Sending of 0 - 63
	1 Byte		CT----	DPT_SceneControl	0-63; 128-191	[Ix] [Long Press] Save Scene	Sending of 128 - 191
	1 Bit	O	CTR--	DPT_Alarm	0/1	[Ix] [Switch/Sensor] Alarm: Breakdown or sabotage	1 = Alarm; 0 = No Alarm
	2 Bytes		CT----	9.xxx	-671088.64 - 670760.96	[Ix] [Long Press] Constant Value (Float)	Float value
	2 Bytes		CT----	DPT_Value_2_Ucount	0 - 65535	[Ix] [Long Press] Constant Value (Integer)	0 - 65535
	1 Byte		CT----	DPT_Scaling	0% - 100%	[Ix] [Long Press] Constant Value (Percentage)	0% - 100%
	1 Byte		CT----	DPT_Value_1_Ucount	0 - 255	[Ix] [Long Press] Constant Value (Integer)	0 - 255
65, 71	1 Bit		CT----	DPT_Trigger	0/1	[Ix] [Long Press/Release] Stop Shutter	Release -> Stop Shutter
66, 72	1 Byte	I	C--W-	DPT_Scaling	0% - 100%	[Ix] [Long Press] Dimming Status (Input)	0% - 100%
	1 Byte	I	C--W-	DPT_Scaling	0% - 100%	[Ix] [Long Press] Shutter Status (Input)	0% = Top; 100% = Bottom
73	1 Byte	I	C--W-	DPT_SceneControl	0-63; 128-191	[Motion Detector] Scene Input	Scene Value
74	1 Byte		CT----	DPT_SceneControl	0-63; 128-191	[Motion Detector] Scene Output	Scene Value
75, 104	1 Byte	O	CTR--	DPT_Scaling	0% - 100%	[I1] Luminosity	0-100%
76, 105	1 Bit	O	CTR--	DPT_Alarm	0/1	[I1] Open Circuit Error	0 = No Error; 1 = Open Circuit Error
77, 106	1 Bit	O	CTR--	DPT_Alarm	0/1	[I1] Short Circuit Error	0 = No Error; 1 = Short Circuit Error
78, 107	1 Byte	O	CTR--	DPT_Scaling	0% - 100%	[I1] Presence State (Scaling)	0-100%
79, 108	1 Byte	O	CTR--	DPT_HVACMode	1=Comfort 2=Standby 3=Economy 4=Building Protection	[I1] Presence State (HVAC)	Auto, Comfort, Standby, Economy, Building Protection
80, 109	1 Bit	O	CTR--	DPT_Occupancy	0/1	[I1] Presence State (Binary)	Binary Value
	1 Bit	O	CTR--	DPT_Trigger	0/1	[I1] Presence: Slave Output	1 = Motion Detected
81, 110	1 Bit	I	C--W-	DPT_Window_Door	0/1	[I1] Presence Trigger	Binary Value to Trigger the Presence Detection
82, 111	1 Bit	I	C--W-	DPT_Trigger	0/1	[I1] Presence: Slave Input	0 = Nothing; 1 = Detection from slave device
83, 112	2	I	C--W-	DPT_TimePeriodSec	0-65535	[I1] Presence: Waiting Time	0-65535 s.

	Bytes						
84, 113	2 Bytes	I	C - - W -	DPT_TimePeriodSec	1-65535	[I1] Presence: Listening Time	1-65535 s.
85, 114	1 Bit	I	C - - W -	DPT_Switch	0/1	[I1] Presence: Lock	According to parameters
86, 115	1 Bit	I	C - - W -	DPT_Switch	0/1	[I1] Presence: Day/Night	According to parameters
87, 116	1 Bit	O	C T R - -	DPT_Occupancy	0/1	[I1] Presence: Occupancy State	0 = Not Occupied; 1 = Occupied
88, 117	1 Bit	I	C - - W -	DPT_Trigger	0/1	[I1] External Motion Detection	0 = Nothing; 1 = Motion detected by an external sensor
89, 118	1 Byte	O	C T R - -	DPT_Scaling	0% - 100%	[I1] [C1] Detection State (Scaling)	0-100%
90, 119	1 Byte	O	C T R - -	DPT_HVACMode	1=Comfort 2=Standby 3=Economy 4=Building Protection	[I1] [C1] Detection State (HVAC)	Auto, Comfort, Standby, Economy, Building Protection
91, 120	1 Bit	O	C T R - -	DPT_Switch	0/1	[I1] [C1] Detection State (Binary)	Binary Value
92, 121	1 Bit	I	C - - W -	DPT_Switch	0/1	[I1] [C1] Channel Lock	According to parameters
93, 122	1 Bit	I	C - - W -	DPT_Switch	0/1	[I1] [C1] Force State	0 = No Detection; 1 = Detection
94, 123	1 Byte	O	C T R - -	DPT_Scaling	0% - 100%	[I1] [C2] Detection State (Scaling)	0-100%
95, 124	1 Byte	O	C T R - -	DPT_HVACMode	1=Comfort 2=Standby 3=Economy 4=Building Protection	[I1] [C2] Detection State (HVAC)	Auto, Comfort, Standby, Economy, Building Protection
96, 125	1 Bit	O	C T R - -	DPT_Switch	0/1	[I1] [C2] Detection State (Binary)	Binary Value
97, 126	1 Bit	I	C - - W -	DPT_Switch	0/1	[I1] [C2] Channel Lock	According to parameters
98, 127	1 Bit	I	C - - W -	DPT_Switch	0/1	[I1] [C2] Force State	0 = No Detection; 1 = Detection
99, 128	1 Byte	O	C T R - -	DPT_Scaling	0% - 100%	[I1] [C3] Detection State (Scaling)	0-100%
100, 129	1 Byte	O	C T R - -	DPT_HVACMode	1=Comfort 2=Standby 3=Economy 4=Building Protection	[I1] [C3] Detection State (HVAC)	Auto, Comfort, Standby, Economy, Building Protection
101, 130	1 Bit	O	C T R - -	DPT_Switch	0/1	[I1] [C3] Detection State (Binary)	Binary Value
102, 131	1 Bit	I	C - - W -	DPT_Switch	0/1	[I1] [C3] Channel Lock	According to parameters
103, 132	1 Bit	I	C - - W -	DPT_Switch	0/1	[I1] [C3] Force State	0 = No Detection; 1 = Detection
133-164	1 Bit	I	C - - W -	DPT_Bool	0/1	[LF] (1 bit) Data Entry X	Binary Data Entry (0/1)
165-180	1 Byte	I	C - - W -	DPT_Value_1_Ucount	0 - 255	[LF] (1 byte) Data Entry X	1 byte Data Entry (0-255)
181-196	2 Byte	I	C - - W -	DPT_Value_2_Ucount	0 - 65535	[LF] (2 bytes) Data Entry X	2 bytes Data Entry
	2 Byte	I	C - - W -	DPT_Value_2_Count	-32768 - 32767	[LF] (2 bytes) Data Entry X	2 bytes Data Entry
	2 Byte	I	C - - W -	DPT_Value_Temp	-273,00 - 670760,00	[LF] (2 bytes) Data Entry X	2 bytes Data Entry
197-204	4 Byte	I	C - - W -	DPT_Value_4_Count	-2147483648 - 2147483647	[LF] (4 bytes) Data Entry X	4 bytes Data Entry

205-214	1 Bit	O	CTR--	DPT_Bool	0/1	[LF] Function X - Result	(1 bit) Boolean
	1 Byte	O	CTR--	DPT_Value_1_Ucount	0 - 255	[LF] Function X - Result	(1 byte) Unsigned
	2 Byte	O	CTR--	DPT_Value_2_Ucount	0 - 65535	[LF] Function X - Result	(2 bytes) Unsigned
	4 Byte	O	CTR--	DPT_Value_4_Count	-2147483648 - 2147483647	[LF] Function X - Result	(4 bytes) Signed
	1 Byte	O	CTR--	DPT_Scaling	0% - 100%	[LF] Function X - Result	(1 byte) Percentage
	2 Byte	O	CTR--	DPT_Value_2_Count	-32768 - 32767	[LF] Function X - Result	(2 bytes) Signed
	2 Byte	O	CTR--	DPT_Value_Temp	-273.00 - 670760.00	[LF] Function X - Result	(2 bytes) Float

Join and send us your inquiries
about Zennio devices:

<http://support.zennio.com>

Zennio Avance y Tecnología S.L.

C/ Río Jarama, 132. Nave P-8.11
45007 Toledo (Spain).

Tel. +34 925 232 002.

www.zennio.com
info@zennio.com



RoHS